

ALUMINIUM GANTRY CRANE, movable under load
load capacity 1.500 kg with double beam
beam length 5.000 - 8.000 mm

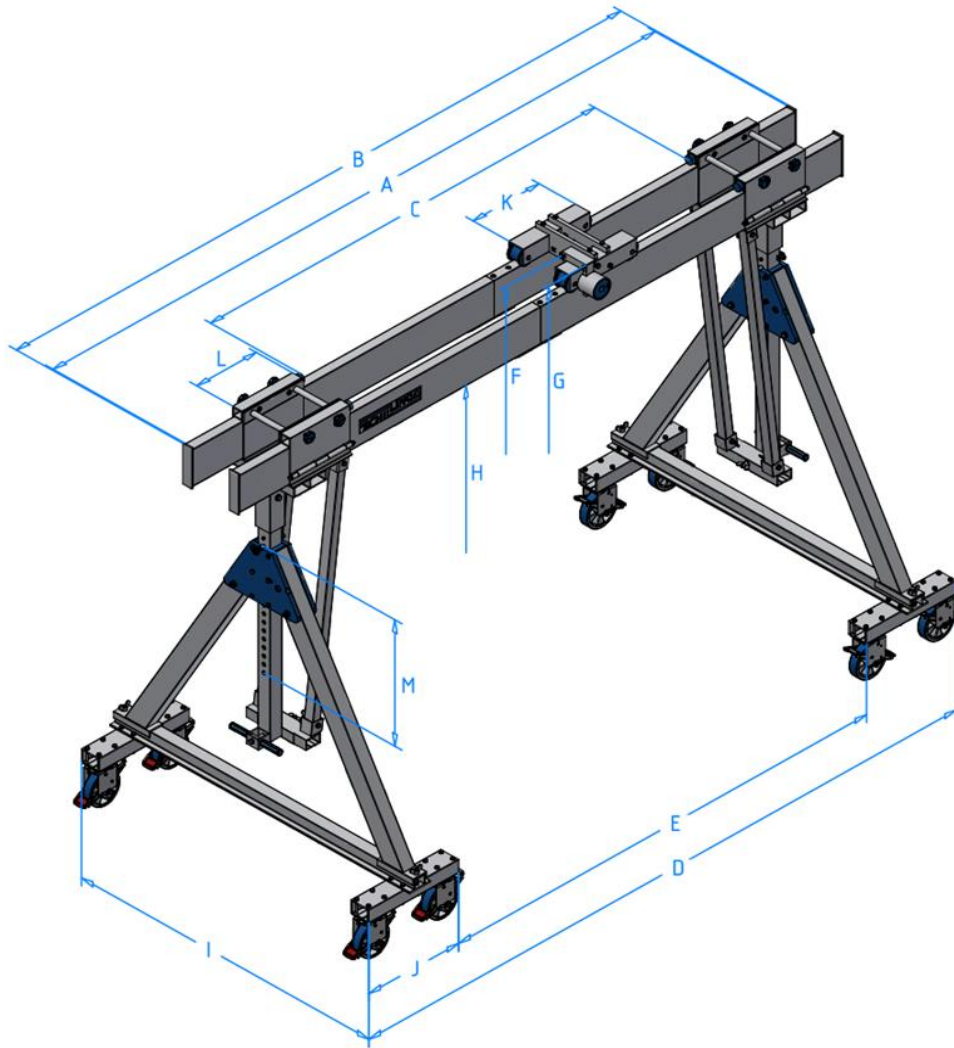

item no.	load capacity	beam length			total width of the crane		suspension point at the bolt of the trolley		total height		lower edge alu beam		lateral stand		park-brake trolley	horizontal adjuster	adjustment range	weight
		clear width	total	usable	outside	inside	min.	max.	min.	max.	min.	max.	width	depth				
	kg	A	B	C	D	E	F	G	H	I	J	K	L	M				kg
SMALL																		
14401550-10	1500	5000	5016	4158	5482	4290	2135	2485	2235	2585	1868	2218	1488	596	480	421	350	350
14401560-10	1500	6000	6016	5158	6482	5290	2135	2485	2235	2585	1868	2218	1488	596	480	421	350	368
14401570-10	1500	7000	7016	6158	7482	6290	2135	2485	2235	2585	1868	2218	1488	596	480	421	350	385
14401580-10	1500	8000	8016	7158	8482	7290	2135	2485	2235	2585	1868	2218	1488	596	480	421	350	403
MEDIUM																		
14501550-10	1500	5000	5016	4158	5482	4290	2613	3363	2713	3463	2346	3096	1988	596	480	421	750	383
14501560-10	1500	6000	6016	5158	6482	5290	2613	3363	2713	3463	2346	3096	1988	596	480	421	750	401
14501570-10	1500	7000	7016	6158	7482	6290	2613	3363	2713	3463	2346	3096	1988	596	480	421	750	418
14501580-10	1500	8000	8016	7158	8482	7290	2613	3363	2713	3463	2346	3096	1988	596	480	421	750	435
HIGH																		
14601550-10	1500	5000	5016	4158	5482	4290	3004	4154	3104	4254	2737	3887	2312	596	480	421	1150	409
14601560-10	1500	6000	6016	5158	6482	5290	3004	4154	3104	4254	2737	3887	2312	596	480	421	1150	427
14601570-10	1500	7000	7016	6158	7482	6290	3004	4154	3104	4254	2737	3887	2312	596	480	421	1150	444
14601580-10	1500	8000	8016	7158	8482	7290	3004	4154	3104	4254	2737	3887	2312	596	480	421	1150	462